

Powder Clutch

MODEL

ZKA-A Powder Clutch

ZKA-AT Powder Clutch

Instruction Manual

Table of Contents

Cautions on Safety - - - - -	1
1. Cautions before use - - - - -	2
2. Structure and principle of operation - - - - -	2
3. Assembling of clutch - - - - -	4
4. Operation- - - - -	6
5. Torque adjustment - - - - -	7
6. Maintenance - - - - -	8
7. Troubleshooting - - - - -	9
8. Specification- - - - -	10
9.Others - - - - -	11



- Read through this manual, and use the unit correctly.
Make sure to understand “Cautions on safety” completely.
- Store this manual carefully, and make sure to send it to the end user.

Cautions on Safety

(Make sure to read this page before using the unit.)







Please read through this instruction manual and other technical data, and handle the unit correctly while paying rigid attention to safety.

In this manual, the level of safety precautions are classified into “**DANGER**” and “**CAUTION**”.

 DANGER	: Erroneous handling may cause a dangerous situation in which the possibility of death or serious injury is expected.
 CAUTION	: Erroneous handling may cause a dangerous situation in which the possibility of not so serious or slight injury is expected or occurrence of material damages exclusively is expected.

In case of trouble, in spite of our best efforts in quality control, it may be assumed to cause continuous running state due to failure of the clutch and the brake, and hence it is advised to pay sufficient consideration to safety measures at the machine side.

Store this manual carefully so that it can be referred to when required, and make sure to send it to the end user.

 DANGER	Use protective cover.
	The rotating elements are exposed outside, and the hand or part of body may be injured if touching the product. Install a protective cover, allowing smooth ventilation, so that part of the body may not be in contact with the machine. It is also recommended to provide with a safety mechanism to stop the rotating elements immediately when the cover is opened.
 DANGER	Never use the unit in an atmosphere in which inflammation or explosion is expected.
	While slipping, a spark may be ignited on the internal working surface. Never use in a flammable or explosive atmosphere with oil or grease. Use pressure-proof and explosion-proof type. Enclose the main body when using near flammable material such as cotton. When enclosed, however, it must be noted that the allowable heat dissipation is lowered.
 DANGER	Keep the product away from water, oil, and grease.
	Not only the working surface but also the product main body should be protected from water, oil, and grease. If water, oil, or grease is on the main body, it may flow to the working surface and may remarkably lower the torque. As a result, the machine may not stop at the specified point due to inertial run, or may run at an abnormal speed. Such abnormal operation of the machine may cause injury.
 CAUTION	Check the environments.
	Never use in a place exposed to dust, high temperature, dew condensation, or rain and wind. Don't install directly in a place exposed to vibration or impact. Or it may lead to damage or malfunction of the product or deterioration of performance.



CAUTION

- Mitsubishi Electric is not responsible for any damage or trouble caused by repair, disassembly or modification of the product by any third party other than Mitsubishi or specified agent.

For repair or disassembly services, therefore, please call the service network of Mitsubishi.

It must be noted that the specification mentioned in the cautions, instruction manual or technical data is subject to change without notice.

1. Cautions before use

 CAUTION	Never touch the parts of slip-ring and brush-holder powder supplied.
	The parts of slip-ring and brush-holder powder supplied are exposed outside, and hand or part of body may be struck by electricity if touching them during operations. During maintenance activities the unit should be turned off using power supply switch.
 CAUTION	If the product is not used for a long time, store the clutch at a non-humid place, or take measures to protect the clutch from moisture.
	If the inside of the product is moistened, the product may be corroded and operation may not be possible, or the performance may be deteriorated.

- (1) The powder is contained inside, and hence never give impact or incline the product.
- (2) Don't leave the product in a damp place.

2. Structure and principle of operation

- The clutch structure is shown in Fig.1~ Fig.4. The drive member linked to the input side and the driven member linked to the output side are disposed concentrically across a powder gap.
- The powder gap is filled with powder (magnetic iron powder), and the coil for passing a magnetic flux to the powder is built in the drive member, and it is designed to feed direct current from outside through brush slip ring.
- While the drive member is rotating, when a current flows in the coil, a magnetic flux is generated as indicated by broken line in the drawing, and the powder is linked like a chain along the magnetic flux, and its coupling force the driven member is driven, and the torque is transmitted to the output side.

When the exciting current is cut off, the magnetic flux disappears, and the coupling force of the powder is eliminated, thereby cutting of transmission of powder to the driven member.

Fig. 1 Structural diagrams of ZKA-1A₁ powder clutch
(representative examples)

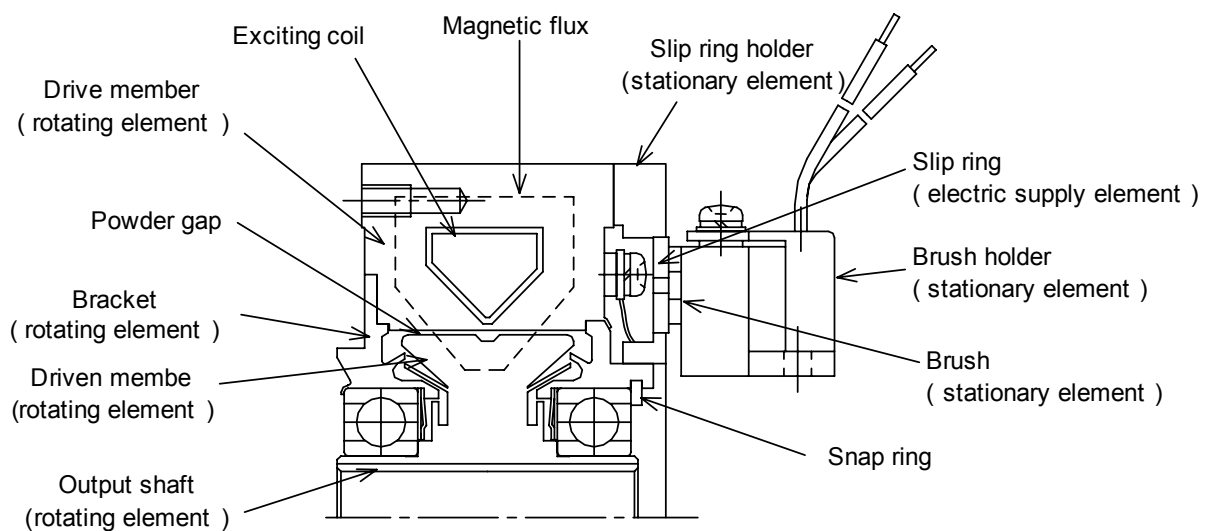

Fig. 2 Structural diagrams of ZKA-2A₁~100A powder clutches
(representative examples)

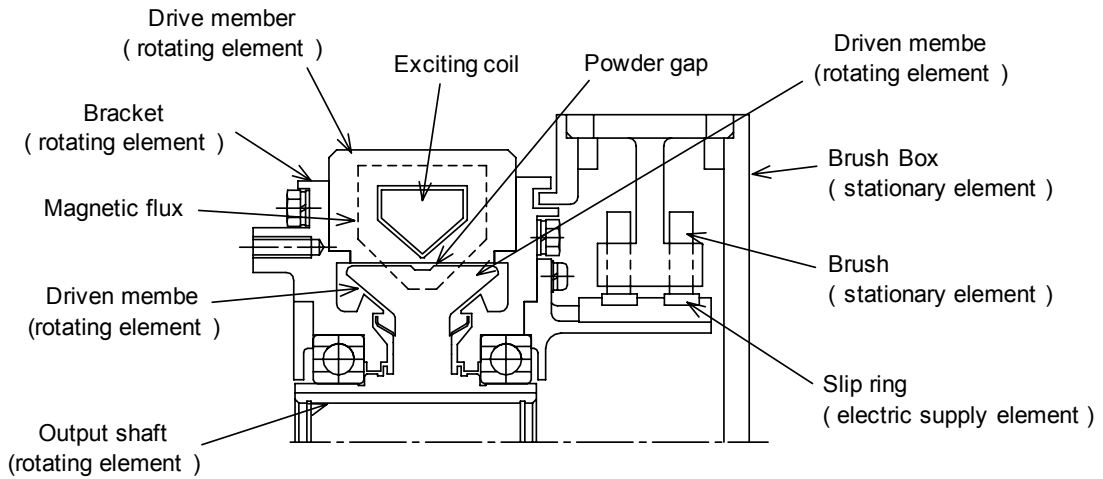

Fig. 3 Structural diagrams of ZKA-200A/400A powder clutches
(representative examples)

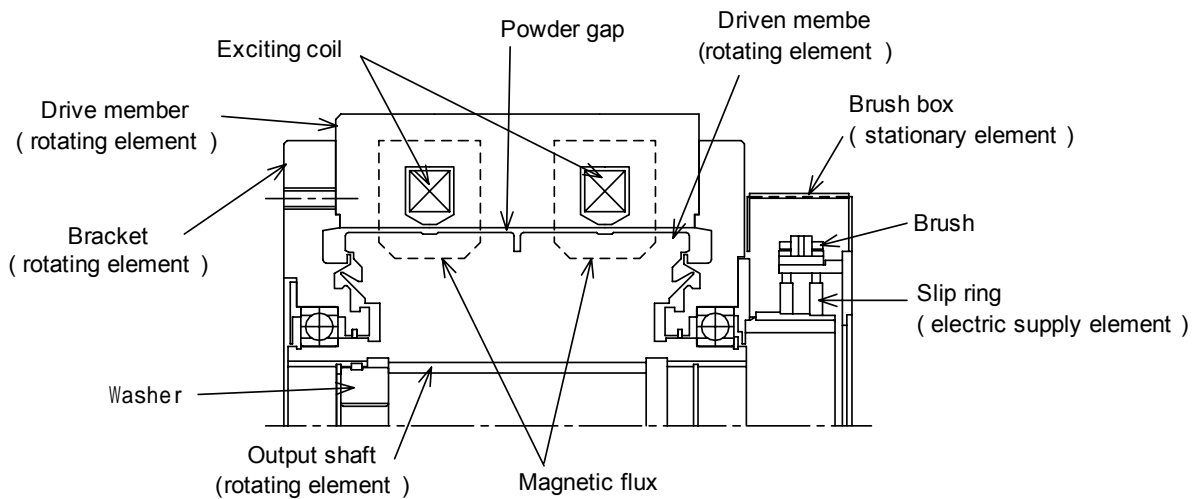
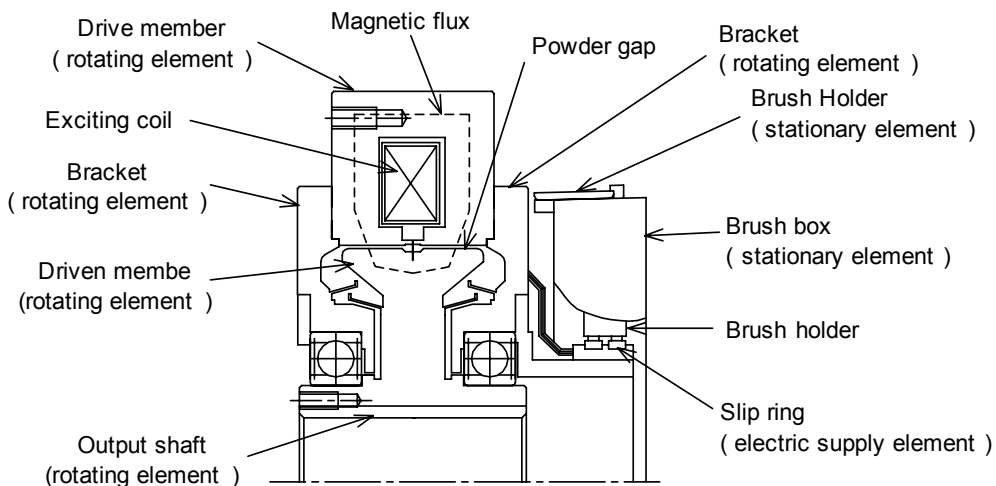











Fig. 4 Structural diagrams of ZKA-45AT~160AT powder clutches
(representative examples)



3. Assembling of clutch, brake

 DANGER	Turn off the power, and make sure rotating elements are stopped
	Never work while rotating, or it may cause electric shock or injury. When mounting, dismounting, or adjusting, turn off the power source, and make sure the rotating elements are stopped still. At this time, be careful not to have fingers or hand pinched.
 DANGER	Tighten bolts to specified torque, and lock securely.
	Depending on the degree of tightening, the bolts may be broken to cause injury. Using specified bolt material, tighten bolts to specified torque, and lock securely with adhesive, spring washer or the like as specified. Besides, since the parts composing the product rotate relatively to each other, the tightened parts must be fixed securely for the safety of operation. The bolt strength and tightening torque are designated in the specification.
 DANGER	Connect lead wires securely.
	Otherwise it may lead to an electric shock. Connect securely, both electrically and mechanically, and insulate appropriately.
 DANGER	Be sure to connect a surge absorber parallel to the clutch coil to cut off the direct current.
	Cutting off the current may cause a large surge voltage, and the surge voltage may deteriorate the peripheral units. For this reason, be sure to use a surge absorber, such as a diode, varistor, and protective resistor.
 DANGER	Use wire size suited to current capacity.
	If wire of smaller current capacity is used, the insulating coating may melt down to cause insulation failure, possibly leading to electric shock, current leak, or fire. The specified current of the product is designated in the specification.
 CAUTION	Mount, dismount, and transport with greatest care.
	Carrying of a heavy product may cause lumbago or injury by dropping. Be careful sufficiently when mounting, dismounting, or transporting. Components of a product rotate relatively, and hence hold firmly the outer circumference during work. The mass of the product is designated in the specification.

(Note) The hoist operation by using the eyebolts should be done by a qualified operator.



- (1) In assembling work, don't attempt to put in by force.
When inserting into the output shaft, in particular, apply pressure to the shaft of the driven member.
- (2) For coupling with the load shaft, use an elastic coupling.
- (3) For pulley coupling, pay attention to the belt tension, and never apply initial tension more than necessary.
- (4) Insert the shaft of a driven body into a hollow shaft of the driven member, and prevent from slipping out securely.
- (5) Clean the surface of the slip ring with organic solvent, thinner or the like.
- (6) The voltage polarity is not specified.

(7) When coupling of the driving and driven sides is over, install the brush holder assembly, and connect wiring for power feed. Place the brush holder assembly so that the rubber part may come to the bearing pedestal side. (See Fig.5)

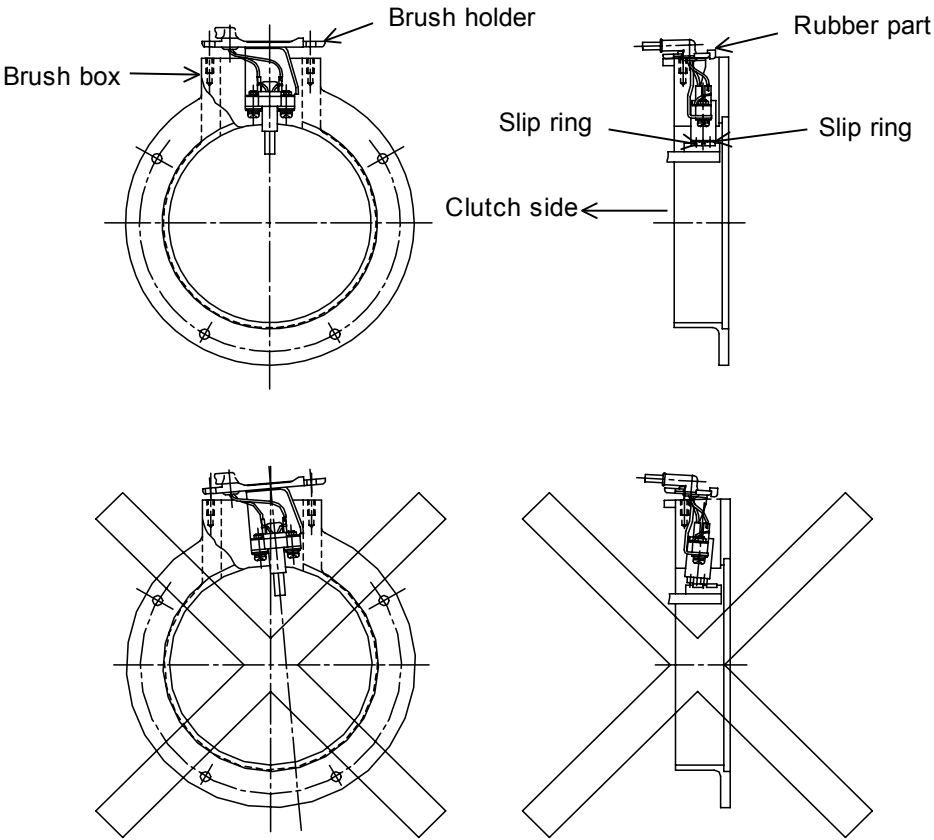
Fig. 5 ZKA-AT Brush holder attach pictures



4. Operation

 DANGER	Never touch the product during operation.
	The rotating elements are exposed outside, and the hand or part of body may be injured if touching the product. Install a protective cover, allowing smooth ventilation, so that the hand or fingers may not be in contact with the machine during operation, and also a safety mechanism to stop the rotating elements immediately when the cover is opened.
 CAUTION	Remove eye-bolts after assembly (ZkA-20A3 or more)
	Eye-bolts are projecting, and may contact safety cover or the like to cause breakage or injury. Remove right after assembling, and then start operation.

- If a shock is applied to the clutch during transportation, powder may be scattered inside the clutch. For this reason, before starting regular operation, perform running-in while following the procedure below to collect powder into the powder gap, if necessary.
- In addition, if the powder is replaced, be sure to perform running-in.

(1)Running-in procedure

 DANGER	Never increase the rotating speed more than allowable.
	If the rotating speed is raised more than allowable, vibration increases to cause breakage and scattering of powder, and it is very dangerous. Rotate within allowable speed, and install protective cover.



- Fix the output shaft to prevent rotation. (If it is difficult to fix the shaft, apply a heavy load to prevent rotation of the output shaft.)
- After that, without flowing the exciting current, rotate the drive member at approximately 200 r/min for 1 minute, and then set the exciting current to 1/4 to 1/2 of the rated value. While rotating the drive member, flow the exciting current for 5 seconds, and then stop flowing the current for 10 seconds. Repeat this cycle approximately 10 times.

(2) End of running-in

- While the running-in is insufficient, the torque output may be low or the torque may fluctuate, but as the running-in becomes sufficient and the powder comes to work effectively, a stable torque corresponding to the exciting current is produced.

- After the running-in, start regular operation.
- Depending on the conditions of use, the drive member surface temperature may rise considerably. Use the product while keeping the surface temperature below 90°C (ZKA-AT : below100°C). If the surface temperature exceeds the limit, relax the operation conditions, and prevent overheat of the clutch.
- The above-described surface temperature is a reference value. Be sure to use the clutch within the allowable heat dissipation.

(Herein, the surface temperature is mentioned on the basis of the ambient temperature of 30°C. The allowable ambient temperature range is 0 to 40°C.)

 CAUTION	Use thermometer when measuring temperature.
	Don't touch directly by hand to avoid burns. Turn off the power source, and make sure the rotating elements are stopped still, and measure with thermometer. Measure promptly.

5. Torque adjustment

 DANGER	Use within rated torque.
<p>If used over the rated torque, not only the performance deteriorates, but also mechanical breakage or injury may be caused. Hence, use with rated torque. In particular, it must be noted that a torque over the rating may be cause even if used at the rated current, and therefore check the current-torque characteristic, and adjust the exciting current.</p> <p>(In the course of use, the torque gradually declines, and therefore in manufacturing, a proper allowance is considered initially.)</p>	

- The relation of torque and exciting current is almost proportional as shown in Fig. 6, and therefore by adjusting the current, the torque can be easily adjusted.
- Set to a proper value in consideration of the finish of the product or working condition.



 DANGER	Use within the allowable heat dissipation.
	<p>If used over allowable heat dissipation, the clutch may be extremely heated, and the working surface may be extremely hot and red. As a result, a fire may be caused. In addition, the performance may be deteriorated. Be sure to use within the allowable heat dissipation (refer to Fig. 7).</p>

Fig. 6 Exciting current vs. torque characteristics
(representative examples)

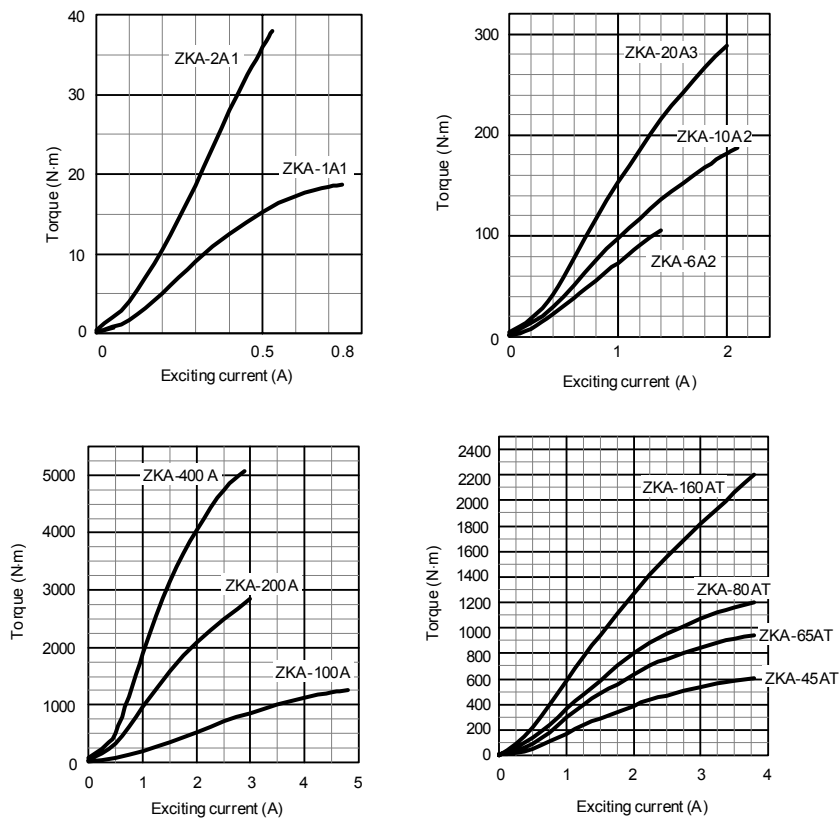
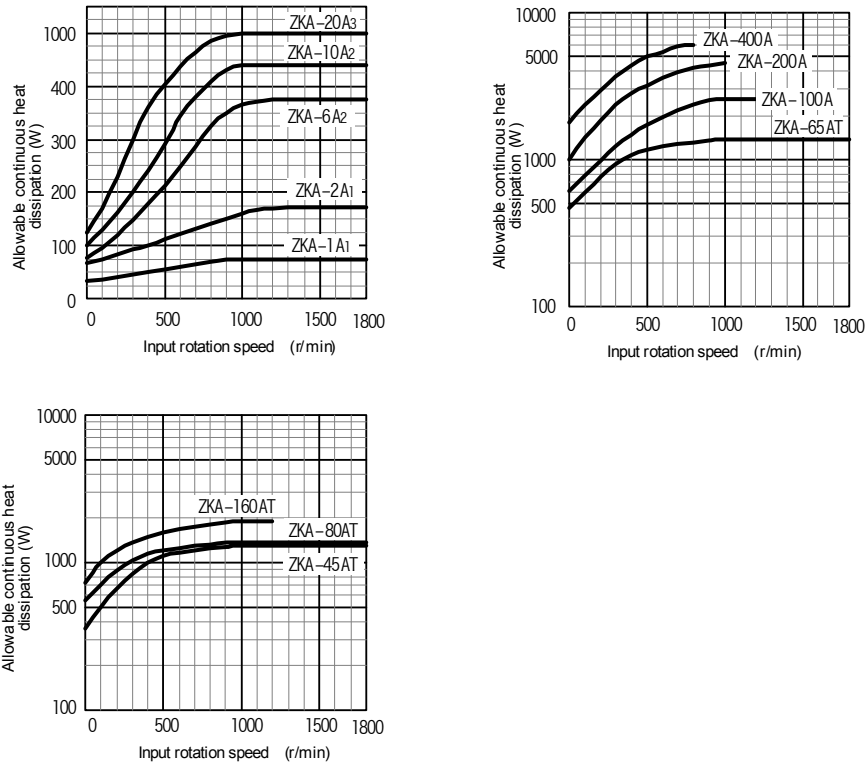



Fig.7 Allowable continuous heat dissipation characteristics



6. Maintenance

Check the following items.

 DANGER	Turn off the power, and make sure rotating elements are stopped.
	Never work while rotating, or it may cause injury. When checking, turn off the power source, and make sure the rotating elements are stopped still. At this time, be careful not to have fingers or hand pinched.

(1) When the powder is moist, the expected performance may not be exhibited.

Be careful not to admit water or oily material inside the clutch.

In particular, if used near the gear box, the oil may invade through the shaft, and therefore perfect oil sealing is advised.

(2) The powder replacement timing cannot be indicated clearly because the powder life varies depending on the conditions of use (slip rotation speed, heat dissipation). Judge the replacement timing when the torque decreases to 70% or less of the initial value. However, it is actually difficult to check the torque. Even if the torque has decreased, it increases when the exciting current increases. Therefore, if the specified torque cannot be obtained at the rated current, replace the powder.



To replace the powder, please contact our service network.

(3) Check the coupling mounting bolts and others for looseness.

 CAUTION	When disposing of this product at the end of its service life, please follow local and national guidelines for the disposal of industrial products.
----------------------------------------------------------------------------------------------------	-----------------------------------------------------------------------------------------------------------------------------------------------------

7. Troubleshooting

Trouble	Cause	Remedy
<ul style="list-style-type: none"> • Torque output is low. • Torque is not generated by passing exciting current. 	<ul style="list-style-type: none"> • Insufficient running-in. • Powder is moistened by water or oil. • Deterioration of powder. • Brush wearing. 	<ul style="list-style-type: none"> • Run in again. • Change powder. • Change brush
<ul style="list-style-type: none"> • Torque is generated without passing current. • Torque fluctuates on every rotation. 	<ul style="list-style-type: none"> • Defective bearing. • Deterioration or sintering of powder. 	<ul style="list-style-type: none"> • Replace bearing. • Change powder.
<ul style="list-style-type: none"> • Surface temperature exceeds 90°C (ZKA-AT surface exceeds 100°C) 	<ul style="list-style-type: none"> • Overload. 	<ul style="list-style-type: none"> • Relax the conditions of use.

 CAUTION	Use thermometer when measuring temperature.
	Don't touch directly by hand to avoid burns. Turn off the power source, and make sure the rotating elements are stopped still, and measure with thermometer. Measure promptly.

In the event of a serious trouble or when replacing parts, call our agent, service center, or sales office, by specifying the manufacturing serial number together with the type name of the clutch.
For repair or disassembly services, please call our designated service network.

Mitsubishi Electric is not responsible for any damage or trouble caused by repair, disassembly or modification of the product by any third party other than Mitsubishi or specified agent.

8. Specification

• ZKA-A Powder clutch

Specification	Type	ZKA-1A1	ZKA-2A1	ZKA-6A2	ZKA-10A2	ZKA-20A3	ZKA-100A	ZKA-200A	ZKA-400A
Torque (N•m)		10	20	60	100	200	1000	2000	4000
Rated current (A/75°C)		0.74	0.53	1.4	2.1	2.0	4.8	3.0	2.9
Rated voltage(DCV)		24						80	
Coil resistance (Ω /75°C)		32.7	45.0	16.9	11.7	12.0	5.0	27.2	27.6
Coil insulation resistance		10 M Ω or more by DC 500 V megger, at ordinary temperature and humidity							
Powder mass (g)		11	40	110	200	270	1115	2100	4210
Product mass (kg)		3.5	7	16	22	36	230	390	720
Bearing		6004	6006	6009	6011	6014	6022	6024	6030
Allowable continuous heat dissipation (W)		Refer to fig. 7							
Max. allowable engaging energy (J) Duty : one time / hour		9×10^4	2.1×10^5	5.3×10^5	7.1×10^5	1.1×10^6	3.4×10^6	5.8×10^6	8.0×10^6
Bracket, drive member tightening bolt strength		Strength division II column 4T or equivalent of JIS B 1051 for mechanical properties of bolts and machine screws.							
Tightening torque (N•m)		2.1~3.6		3.7 ~6.2	8.9~14.7		30 ~50	80 ~120	150 ~250
Allowable rotating speed (r/min)		1800					1200	1000	800

• ZKA-AT Powder clutch

Rated voltage : DC24V

Specification	Type	ZKA-45AT	ZKA-65AT	ZKA-80AT	ZKA-160AT
Torque (N•m)		450	650	800	1600
Rated current (A/75°C)		3.8			
Coil resistance (Ω /75°C)		6.3			
Coil insulation resistance		10 MW or more by DC 500 V megger, at ordinary temperature and humidity			
Powder mass (g)		335	450	522	1150
Product mass (kg)		63	92	106	210
Bearing		6018	6019	6019	6022
Allowable continuous heat dissipation (W)		Refer to fig. 7			
Max. allowable engaging energy (J) Duty : one time / hour		2.0×10^6	2.3×10^6	2.6×10^6	4.4×10^6
Bracket, drive member tightening bolt strength		Strength division II column 4T or equivalent of JIS B 1051 for mechanical properties of bolts and machine screws.			
Tightening torque (N•m)		18~30	30~50		150~250
Allowable rotating speed (r/min)		1800			1200

(Notes)

(1) The bearing is a special product manufactured in consideration of heat resistance and others for making the best of the powder clutch characteristic.

(2) Max. allowable engaging energy

Allowable rotating speed N 1000r/min (ZKA-400A : only =800r/min)

9. Others

(1) In the product having a three-digit figure attached to the model name such as 901 in ZKA-45AT-901, the mounting dimensions, voltage and other conditions are special, and may differ from the description herein, but the basic operation and handling cautions are common.

(2) The structural diagrams are representative examples, and may differ depending on the model and options including the specification. Inquire us for details.